



DSP30 Series Din Rail Power



Technical Data
Installation and Operation

► Fig. 1

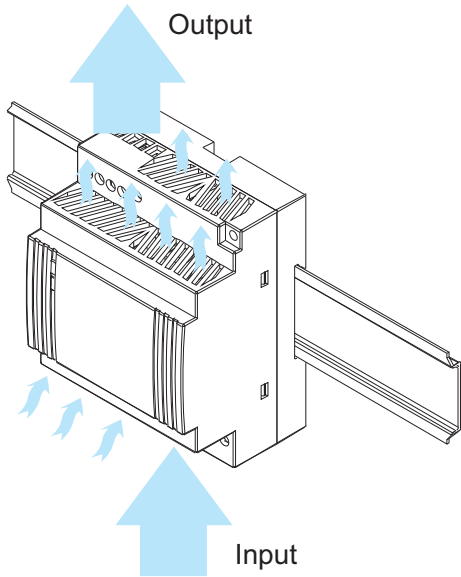

► Fig. 2

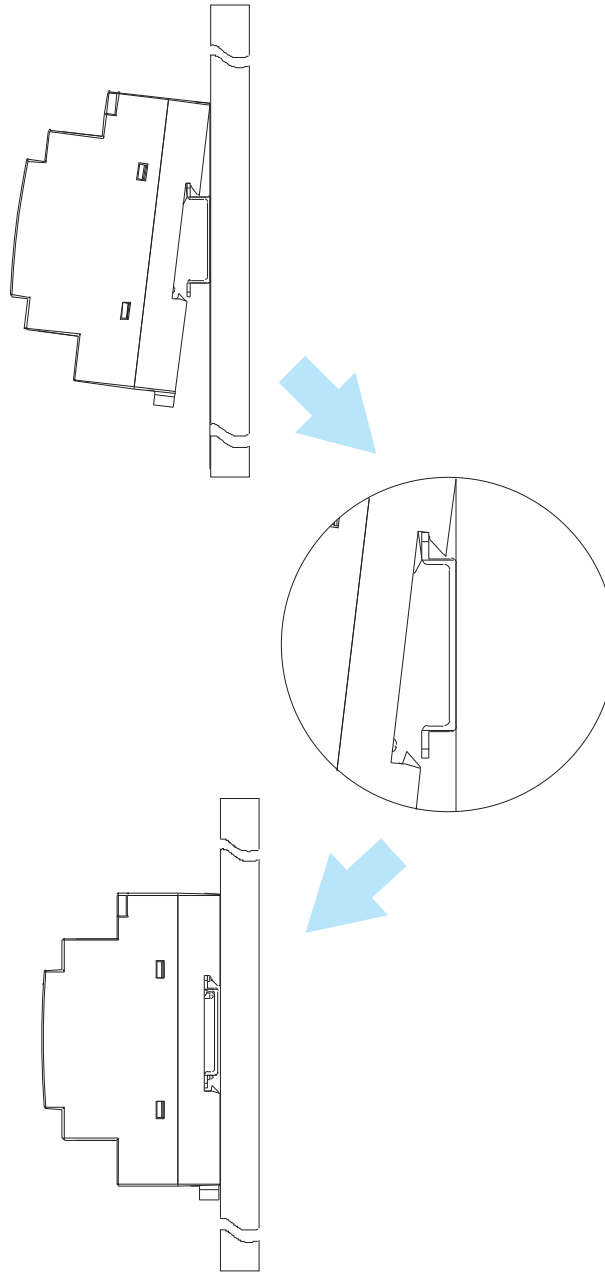

► Fig. 3

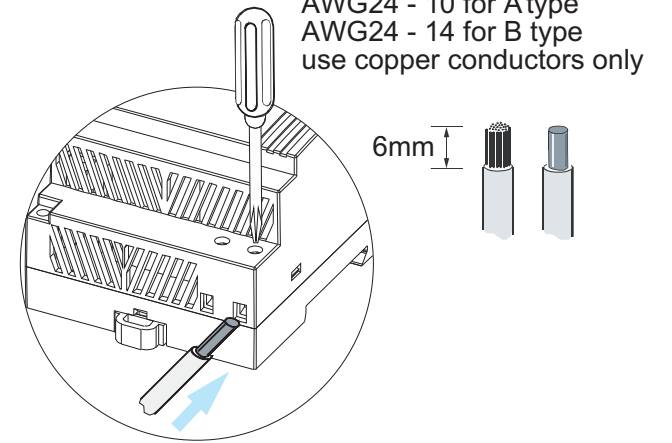

► Fig. 4

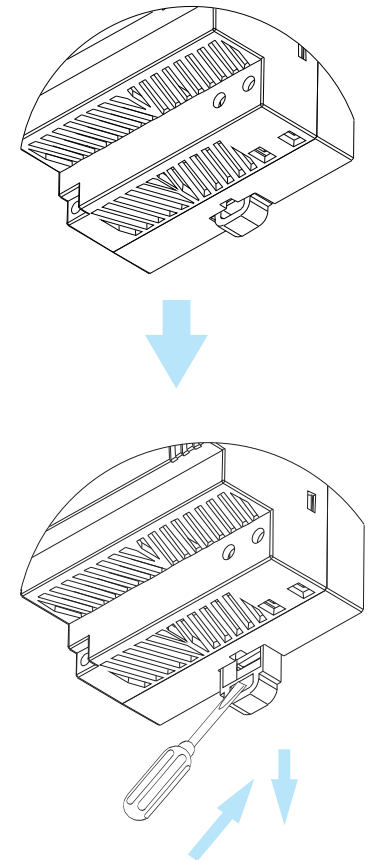



Safety notes

Read Instructions!

Before working with this unit, read these instructions carefully and completely. Make sure that you have understood all the information!
This unit complies with UL1310* for the requirements of NEC Class 2 power only.

Disconnect system from supply network

Before any installation, maintenance or modification work: Disconnect your system from the supply network. Ensure that it cannot be re-connected inadvertently!

Before start of operation

Ensure appropriate installation

Warning! Improper installation / operation impair safety and result in operational difficulties or complete failure of the unit. The unit must be installed and put into service appropriately by qualified personnel. Compliance with the relevant regulations must be ensured. Before operation is begun the following conditions must be ensured, in particular:

- Connection to main power supply in compliance with VDE01000 and EN50178.
- With stranded wires: all strands must be secured in the terminal blocks (potential danger of short circuit).
- Unit and power supply cables must be properly fused; if necessary a manually controlled disconnecting element must be used to disengage from supply mains.
- All output lines must be rated for the power supply output current and must be connected with the correct polarity.
- Sufficient air-cooling must be ensured.

In operation: No modifications!

As long as the unit is in operation: do not modify the installation! The same applies also to the secondary side. Risk of electric arcs and electric shock (fatal)!

Only connect/disconnect when the power is off!

Convection cooling (See Fig. 1)

Do not cover any ventilation holes!
Leave sufficient space around the unit **for cooling!**

Warning: High voltage! Store energy!

The unit contains unprotected conductors carrying a lethal high voltage, and components storing substantial amounts of energy. Improper handling may result in an electric shock or serious burn!

- The unit must not be opened except appropriately trained personnel!
- Do not introduce any object into the unit!
- Keep away from fire and water!

Installation

Mounting (See Fig. 1)

Permissible mounting position: keep ventilation holes clear, leave space for cooling! Recommended to have 25mm free space at all sides:

Snap on support rail (See Fig. 2)

- Tilt the unit slightly rearwards.
- Fit the unit over top hat rail.
- Slide it downward until it hits the stop.
- Press against the bottom front side for locking.
- Shake the unit slightly to check the locking action.

Connection (See Fig. 3)

- Use only commercial cables designed for the indicated voltage and current values!
- With flexible cables: make sure that all stranded cable are secured in the terminal.
- Ensure proper polarity at output terminals!

Removal from DIN Rail (See Fig. 4)

Push the slider downwards (unlock). Gently lift lower front edge of the unit (tipping) and remove.

Technical Data

 All specifications are typical at nominal line, full load, 25°C; Unless otherwise specified.

Description	Model No.			
	DSP30-05	DSP30-12	DSP30-15	DSP30-24
Input				
Rated input Voltage	100Vac ~ 240 Vac			
AC Voltage Range	90Vac ~ 264Vac			
DC Voltage Range	120-375 Vdc			
Frequency	47-63Hz			
Rated input Current (max)	500mA	800mA		
Inrush Current (115Vac/230Vac)	< 25A / < 50A			
Efficiency (Typ)	>74%	>82%	>83%	>83%
Power Factor Correction	meet EN61000-3-2 class A			
Output				
Overvoltage protection	120-145%			
Line regulation	<1.0 %			
Load regulation	<1.0 %			
DC ON indicate (Green LED)	>3V	>9V	>11V	>20V
Ripple	<50mVp-p			
Nominal Current	3A	2.1A	2A	1.3A
Rated over load protection	110%~150%			
Current Limit	Fold Forward (Current rises, voltage drops to maintain constant power during overload)			
Holdup Time (230Vac)	> 30ms			
General				
Temperature	Storage : -25 to + 85 °C , Operation : -25 to+ 71 °C			
Derating (115/230 VAC)	2.5% / °C from 61 to 71 °C			
Humidity	20%~90% RH			
Case	Plastic			
MAX. Required free space	25mm in all sides			
Dimensions	3.58 x 2.08 x 2.19			
H x W x D inches (mm)	(91 x 53 x 55.6)			
Weight (Typ)	200g			
Approvals And Standard				
UL / cUL	UL508 Listed UL1310 Listed Class 2 power, UL 60950-1 Recognized			
TUV	EN60950-1			
CE	EN61000-6-3, EN55022 Class A			
	EN61000-3-2, EN61000-3-3			
	EN61000-6-2, EN55024, EN61000-4-2, EN61000-4-3, EN61000-4-4			
	EN61000-4-5, EN61000-4-6, EN61000-4-8, EN61000-4-11			

* If the units are to be installed as Direct Plug-in Power Units and full compliance to UL1310 is required, the units must be installed in an airtight distributor box that conforms to the requirements of UL1310.

Warning: This is a Class A product. In a residential, commercial or light industrial environment it may cause radio interference. This product is not intended to be installed in a residential environment; in a commercial and light industrial environment with connection to the public mains supply, the user may be required to take adequate measures to reduce interference.